

Gas Chromatograph

Nexis GC-2030



***Nexis* GC-2030**

The Next Industry Standard

Nexis GC-2030, Shimadzu's premier gas chromatograph, offers a modern approach to a classic chromatographic technique. Designed with the user in mind, new innovative features, exceptional performance and high throughput capabilities will elevate your lab to the next level.





SHIMADZU

Nexis GC-2030 GAS CHROMATOGRAPH

Designed with the Analyst in Mind



Information at Your Finger-tips

Analysts will benefit from the touch panel interface, which features clear graphics that display information instantly whenever needed. The user-friendly interface leaves the operator free to focus on obtaining optimal analytical results.

Main settings controllable via the touch panel on the GC unit:

- Analytical conditions
- Self-diagnostics
- Automatic carrier gas leak check
- Chromatogram display, etc.

Making Routine Analysis Convenient with ClickTek

Tool-free Column Installation

ClickTek connectors* make tool free column installation a snap. The click sensation felt when finished attaching the column provides a more reliable connection and ensures a better seal under all operating conditions.

* Optional



ClickTek Connector

One Touch Inlet Maintenance

The injection port can be opened or closed without tools by simply sliding the ClickTek lever. Replace the insert, slide the lever and feel the click for a leak-free install every time.



ClickTek Nut

Intuitive Graphical Icons and Mobile Device Monitoring

Intuitive User Interface

A new user interface ensures the system operating status can be monitored intuitively. Parameter set points can be specified by clicking the graphical icon for that unit. A remote access function* is also available for remotely accessing the laboratory GC unit directly from a smartphone or tablet computer.

* Optional



World's Highest* Sensitivity and Reproducibility



High-Sensitivity Detectors Support a Wide Variety of Analyses

High-Sensitivity Simultaneous Analysis of Inorganic Gases and Lower Hydrocarbons Using Dual BID System



The barrier discharge ionization detector (BID-2030) is a universal detector that offers high-sensitivity analysis by using a low-frequency dielectric barrier discharge plasma for ionization. The BID generates a helium (He) plasma by applying a high voltage to a quartz glass tube. The light energy from the He plasma then ionizes the target components and the ions are

collected and output as peaks using a collection electrode. Its universal detection capability and high sensitivity make it the perfect choice for the analysis of inorganic gases and light hydrocarbons at ppm-level concentrations. The Nexis GC-2030 can be equipped with up to two BID-2030 detectors for increased productivity or separation versatility.

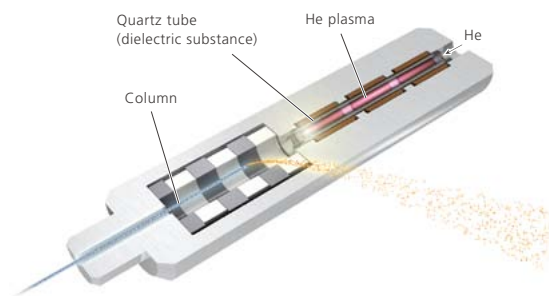
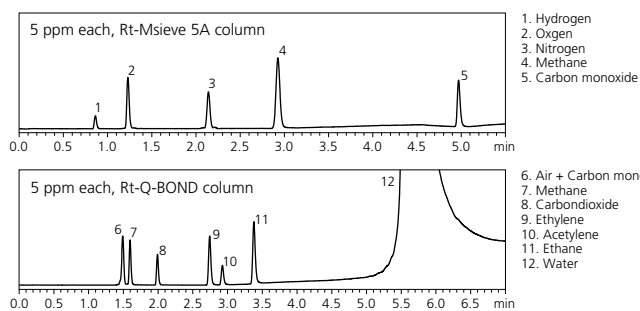

Barrier Discharge Ionization Detector (BID-2030)

High-Sensitivity Simultaneous Analysis of Inorganic Gases and Lower Hydrocarbons Using Dual BID System

Analysis of Residual Solvents in Pharmaceuticals



The jet and collector structure on the flame ionization detector (FID-2030) has been optimized to provide improved performance. Noise levels were also decreased by improving the stability of the signal processor and flow controller. This results in the world's most sensitive FID. This makes the Nexis GC-2030 the best choice to measure residual solvents in pharmaceuticals.

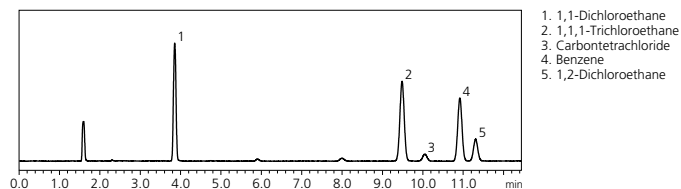

Analysis of Trace Residual Solvents in Pharmaceuticals Using Headspace GC, Class 1 Standard Solution

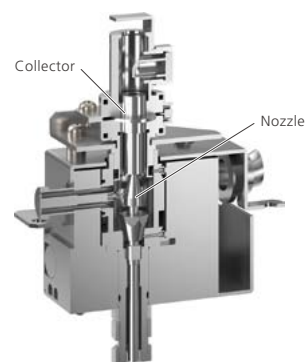

Flame Ionization Detector (FID-2030)

Analysis of Volatile Organic Compounds (VOCs) in Effluent Water

The electron capture detector, ECD-2010 Exceed, features a uniquely designed internal structure that protects the source from contamination while providing exceptional sensitivity. The result is a detector that will last longer between cleanings to provide greater productivity and maximize your ROI.

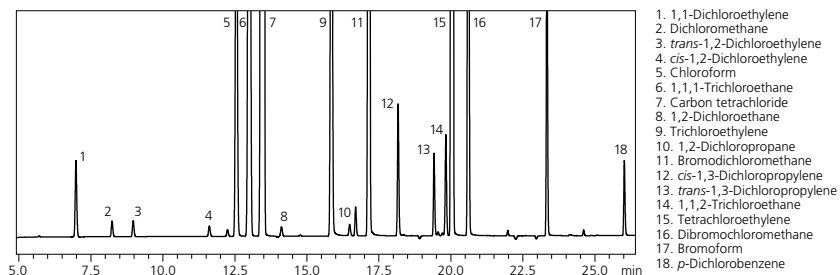

Analysis of Volatile Organic Compounds (VOCs) in Effluent Water Using Headspace GC

ECD

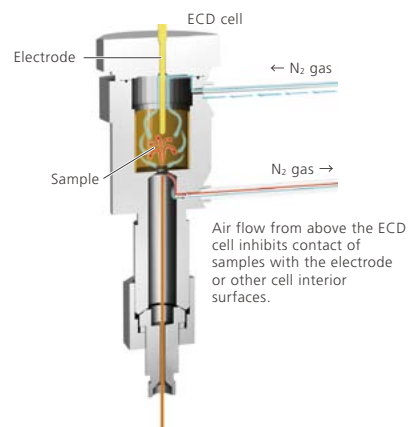

Electron Capture Detector (ECD-2010 Exceed)

Analysis of Organic Phosphorus Pesticides in Food

The flame photometric detector (FPD-2030) features an optimized flame shape and a more advanced dual-focus system, which result in the world's most sensitive FPD*. It can detect ultra-trace quantities of organic phosphorus pesticides in food with higher sensitivity.

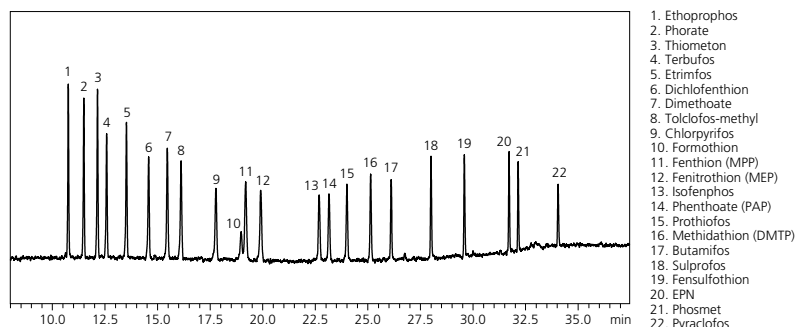

Splittless Analysis of 5 µg/L Organic Phosphorus Pesticide Standards for Each Component

FPD

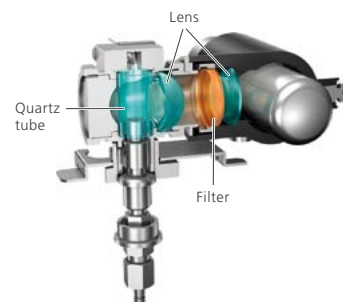

Flame Photometric Detector (FPD-2030)

Intelligent Flow Controller with Exceptional Reproducibility

A new advanced flow controller (AFC) has been developed to include a CPU. It supports carrier gas constant linear velocity control, constant flowrate control, constant pressure control, and various other control modes and achieves exceptionally high reproducibility for ultra-high-speed and ultra-high-precision control modes. Multi-step programs can be created for each control mode as well. The split line filter can be replaced with hands. Internal contamination can be confirmed visually to ensure filters are replaced at the proper timing.

Results from Analyzing a Grob Test Mix Standard Ten Consecutive Times

	Peak Area Value RSD%	Retention Time RSD%
Decane	0.29	0.005
1-Octanol	0.32	0.004
Undecane	0.28	0.004
2,6-dimethylaniline	0.29	0.003
n-Metyl Nonanoate	0.24	0.003
n-Metyl Decanoate	0.25	0.002
Dicyclohexylamine	0.23	0.003
n-Metyl Laurate	0.27	0.004



Flow Controller (AFC-2030)

* As of May 2017, according to a Shimadzu survey

Exceptional Extensibility and Productivity



GC Systems Customized for Specific Needs

The Nexis GC-2030 provides powerful support for configuring custom GC systems tailored to user needs. These systems are adjusted and tested at the factory for the given application before shipment, so they are ready to use for measurements as soon as they are delivered.

That means no time is required for developing methods after the system arrives. Two TCD detectors and one FID detector can be installed at the same time. An optional valve box can be added to control up to eight valves from the original four.

Examples of System GC Configurations

Gasoline analysis system

This system is able to measure specific substances in gasoline, such as oxygenates.

Natural gas analysis system

This system is able to analyze components in natural gas, such as shale gas.

Inorganic gas analysis system

This system is able to measure hydrogen and various other inorganic gases.

Hydrocarbon analysis system

This system is able to measure hydrocarbons that are generated, such as from catalyst reactions.

Refinery gas analysis system

This system is able to analyze components in gas from petroleum refineries.

Public utility natural gas analysis system

This system is able to calculate calorific values from measurements of natural gas.



Advanced Flow Technology

Advanced Flow Technology (AFT) function increases analytical productivity with backflush, detector splitting, and other systems. With the Nexis GC-2030, methods can be specified either via the LabSolutions GC software or directly via the touch panel on the GC unit, without having to use any tedious specialized wizard software.

Shorter Analysis Time — Backflush System

Once target compounds have been detected, the backflush system reverses the carrier gas flow to discharge non-eluting components in the column through the injection port. This ability shortens analysis times and improves productivity.

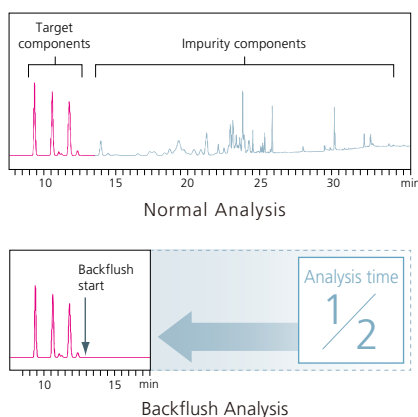

It supports a variety of carrier gas control modes (such as constant linear velocity, constant flowrate, and constant pressure control modes), which ensures analytical conditions can be transferred smoothly from previous systems. Multiple AFT lines can be connected to the same GC unit as well.

Multiple Chromatograms Obtained from a Single Analysis — Detector Splitting System

Multiple chromatograms can be obtained at the same time by using the detector splitting system to split the flow exiting the analytical column and send the eluted components to multiple detectors. Consequently, much more information can be obtained from each analysis, which improves productivity by saving time and reducing costs.

High separation analysis is possible — Heart-cut System

Heart-cut is a method of performing separation using two columns with different selectivity. In this system, components that could not be separated by the first column are introduced into a second column with different properties, and further separation is performed. Heart-cut system can achieve high resolution performance analysis, which is normally difficult to attain by single column analysis.

Faster Analysis with Hydrogen Carrier Gas

Hydrogen can be a safe and highly effective carrier gas. As a highly efficient carrier gas with a flat Van Deemter curve, it maintains its separation efficiency across a wide linear velocity range. This makes it both a good substitute for Helium and also a great choice for speeding up analysis times. We know safety is paramount, which is why the Nexis GC-2030 offers an

optional built-in hydrogen sensor*. It not only maintains a safe standby mode for early detection of any potential leaks, but also shuts off hydrogen flow. The main unit also includes an automatic carrier gas leak check function, which is very helpful when using hydrogen as a carrier gas.

* Optional

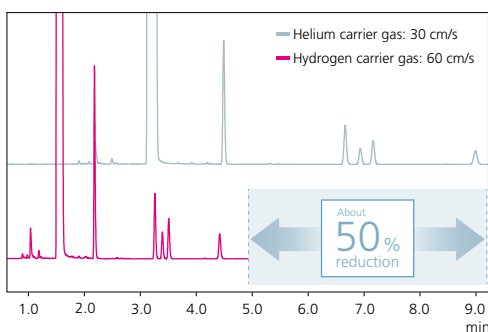

Example of Using a Hydrogen Carrier Gas for High-Speed Analysis of Impurities in Benzene



Hydrogen Sensor* Monitors Inside the GC Oven

Various Advanced Functions Improve Energy Efficiency



Maximized Column Oven Functionality —Column Temperature Control Function—



Column Cooling Rate Selection

Cooling the column oven too quickly could damage the liquid stationary phase in columns. Therefore, the cooling rate on the Nexis GC-2030 can be easily set to three different levels of high, medium and low, to minimize damage to column liquid phases and maximize the column's life time.



Improved Temperature Setting Freedom

Due to the improved temperature control accuracy, the GC oven temperature can be controlled from two degrees above room temperature. That means temperature can be controlled accurately even at temperatures close to room temperature.



Graphical Display of Temperature Program

Temperature programs can be freely edited via the touch panel on the GC unit. Created temperature programs can be displayed in combination with chromatograms.

Minimized Running Costs —Automatic Start and Stop Functions—

The automatic start and automatic stop functions reduce running costs. The automatic stop function can save electricity by automatically stopping GC temperature control when analysis is completed. Later, after a

specified time has elapsed, it also stops carrier gas and detector gas control. The automatic start function starts gas control after a specified period of time and then starts temperature control.

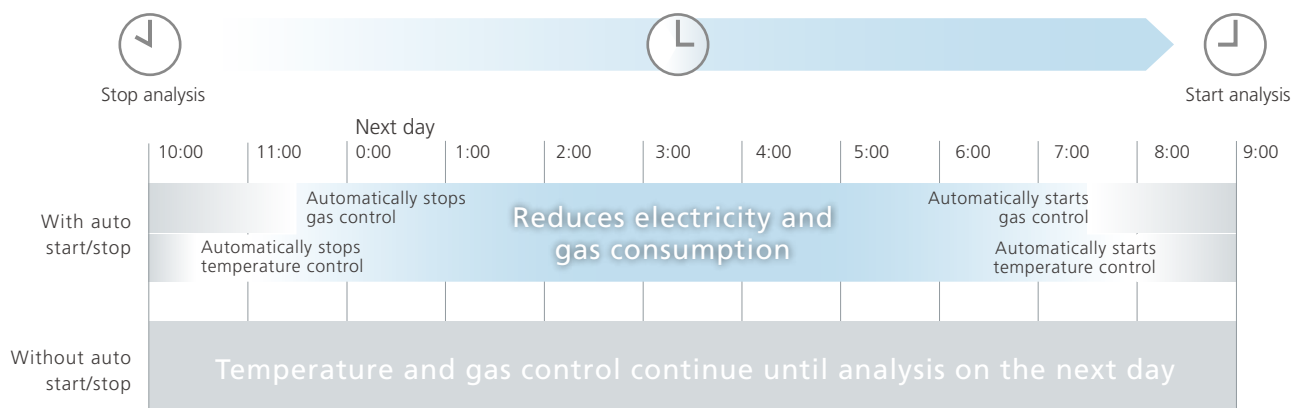

Comparison Between With and Without Using the Automatic Start/Stop Functions

Minimized Helium Gas Consumption —Carrier Gas Saver Function—

Lowering the split ratio during analysis using split/splitless sample injection decreases the carrier gas consumption by reducing the amount of carrier gas discharged outside from the split flow channel.

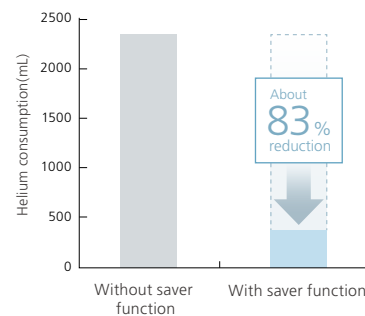
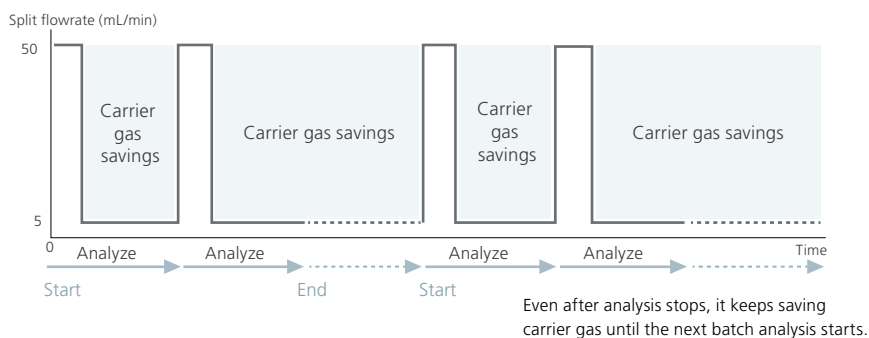

In this example, carrier gas is saved by setting the split flowrate to 50 mL/min only during sample injection and then reducing it to 5 mL/min at all other times. Furthermore, after batch analysis stops, the saver function keeps saving carrier gas while it waits for the next batch analysis to start.

Analysis time: 30 min. Split ratio: 100
 Carrier gas saver function: Split ratio set to "10" one minute later
 Column temperature: 170°C
 Column: 0.25 mm I.D., 30 m long, 0.25 µm film thickness

Diagnoses Instrument Operating Status —Self-Diagnostic Function—

The instrument operating status can be confirmed using the self-diagnostic function (system check). The status can be checked in detail to determine the septum/insert usage status, presence of active temperature sensor errors, gas supply pressure, status of each gas control function, ignition activity status, direct current voltage, and to confirm that the Analog / Digital converter or other functions are functioning properly. Periodically diagnosing the instrument status can help prevent unexpected downtime.

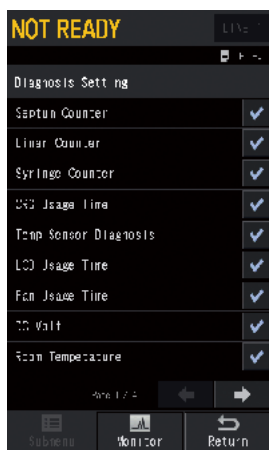

Self-Diagnostic Settings Function Screen

Automatic Notification of Replacement Timing —Monitoring Function—

The Nexis GC-2030 includes various monitoring functions. These functions remind users when to replace consumables and help ensure data quality. Power consumption can also be monitored in real time.

- Syringe usage counter
- Septum usage counter
- Insert usage counter
- Refrigerant consumption monitor
- Power consumption monitor



Analysis Counter Screen

Options for Expanding Your Productivity



Simultaneously Control Up to Three Injection Units and Four Detectors

Up to four types of injection units or six types of detectors can be selected depending on the purpose of analysis and target components. Four detectors can be controlled simultaneously using LabSolutions.

Inlets

Split/Splitless Injector

SPL-2030

- The injection port can be opened or closed without tools, making insert replacement easy. It ensures an airtight seal even at high temperatures and pressures.
- Standard configuration supports high-speed GC with narrow bore capillary columns.
- The carrier gas saver function reduces split gas consumption.
- Permits high-pressure injection mode.

Direct Injection Unit

WBI-2030

- The injection port can be opened or closed without tools, making insert replacement easy. It ensures an airtight seal even at high temperatures and pressures.
- Equipped with a septum purge flow channel to inhibit solvent tailing.
- Shares and simplifies the glass inserts for splitless analysis (patented).

Note: Contact your Shimadzu representative separately regarding connecting a packed column.

On-Column Injection Unit

OCI-2030

- Samples can be injected using cold on-column injection (OCI).
- By using an optional easy OCI insert, cold on-column injection allows a narrow-bore capillary column to be connected directly to the injector without a 0.53 mm I.D. pre-column. (Press-Tight connector not necessary).
- It also supports analysis of high-boiling compounds (straight-chain hydrocarbons with 100 or more carbons)
- Two units of OCI can be mounted at the same time.

Programmed Temperature Vaporization Injector

PTV-2030

- Samples can be injected using the PTV method.
- Uses an inert heat-resistant quartz insert.
- Two units of PTV can be mounted at the same time.



Detectors

Flame Ionization Detector

FID-2030

All organic compounds

- An optimized nozzle and collector structure provides better response than previous models.
- Improved instrument controller and flow controller stability results in lower noise and the world's highest* sensitivity.
- Automatic ignition, re-ignition and flame extinguishing functions are included by default.
- It also includes a feedback function for reducing the gas supply pressure to zero when the hydrogen flame is extinguished unexpectedly.
- Reverse threads are used on hydrogen connector joints to prevent incorrect pipe connections.
- An optional flame monitor can be mounted.

Flame Photometric Detector

FPD-2030

Organic phosphorus compounds
Sulfur compounds

- A novel optical system with a more advanced dual-focus system results in the world's highest sensitivity*.
- The nozzle structure prevents adsorption and decomposition of sample components and an improved nozzle shape heightens flame stability.
- A dedicated cooling fan achieves a more compact design that also enables high-temperature (450 °C) operation.
- Reverse threads are used on hydrogen connector joints to prevent incorrect pipe connections.
- When using LabSolutions, the recommended detector flowrates can be set automatically for optimal sensitivity, by simply selecting the filter type (for phosphorus, sulfur, or tin).

Thermal Conductivity Detector

TCD-2030 (for capillary columns)

Inorganic gases
High-concentration organic compounds

- A microvolume cell supports even sharp peaks.
- An improved structure results in a shorter stabilization time than previous models. It enable more reliable analysis that is less easily affected by column oven temperature.

Flame Thermionic Detector

FTD(NPD)-2030

Organic nitrogen compounds
Organic phosphorus compounds

- An improved collector reduces the negative peaks from impurity components.
- Collectors can be replaced without tools.
- Using an alkali source regeneration kit (optional) can reduce running costs.
- Reverse threads are used on hydrogen connector joints to prevent incorrect pipe connections.

Electron Capture Detector

ECD-2010 Exceed

Electrophilic compounds

- Redesigned internal structure provides increased durability, higher sensitivity, and wider dynamic range, achieving the world's highest* ECD performance.
- An optimized ECD cell structure achieves the world's highest sensitivity.

Barrier Discharge Ionization Detector

BID-2030

Low-concentration inorganic gases
Organic compounds

- A wide variety of compounds other than He and Ne can be detected with high sensitivity.
- Provides over 100 times higher sensitivity than TCD and over 1.5 times higher than FID.
- A barrier discharge plasma source that does not contact the electrode prevents high electrode temperatures. Consequently, electrodes almost never deteriorate, which ensures long-term analytical stability.

* As of May 2017, according to a Shimadzu survey

Notes: In some countries, registration with the appropriate authority for regulation of radioisotopes is required before purchasing or using this detector. (Contact your Shimadzu representative for details.)

Software Improves Laboratory Productivity

LabSolutions Software Fully Integrates LC and GC Functionality

The LabSolutions series is a next-generation workstation software that integrates GC control, LC control, and additional improvements to functionality, while maintaining back-compatibility with the previous GCsolution. It offers sophisticated functionality, easy operation, highly

extensible report functions, and other customizable features. In addition to inheriting these and other concepts from GCsolution, LabSolutions shares a common operating environment.

User-Friendly Interface

The user interface features the same assistant bar, data explorer, and other user-friendly features of the LabSolutions series, to ensure intuitive operability and a short learning period. Operating windows and assistant bar panels, used for navigating operations, can be customized according to the working environment where the system is being used. Consequently, it offers both easy operability and extensive functionality. The new data browser is convenient for comparing multiple sets of data by enabling access to chromatograms, peak information, and quantitation results from multiple data files at the same time.

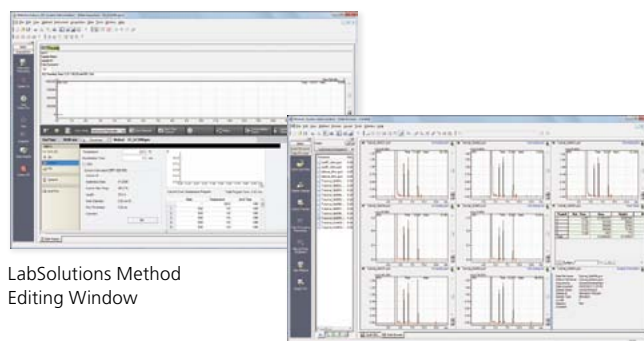

LabSolutions Method Editing Window

LabSolutions Data Browser Window

Quick-Batch Function Simplifies Tedious Process of Creating Injection Sequences (Batch Files)

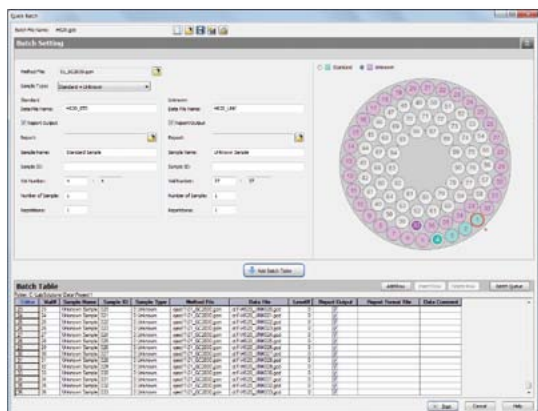

Quick-Batch Window in LabSolutions

The Quick-Batch function in LabSolutions makes it easy to create batch files using simple operations. The Quick Batch window displays a graphic of the sample racks placed in the system. Users can work more quickly and with fewer errors by preparing batch files as they visually confirm the vial positions in the window.

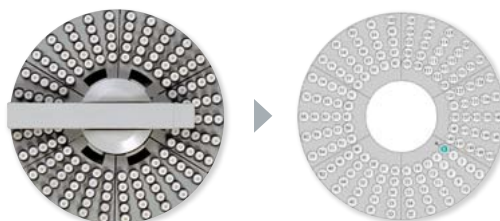

Diagram Accurately Representing the Actual Tray

Freely Accessible Analytical Networks with LabSolutions CS

LabSolutions CS manages all analytical data on the network server, so that the data can be loaded to any computer connected to the network. In addition to sending analysis instructions, monitoring, and controlling instruments not directly connected to the computer (client computer), LabSolutions CS can also be used to directly control non-Shimadzu LC or GC units.

Compliance with Laws and Regulations

- Compliance with FDA 21 CFR Part 11 (United States FDA)
- Use of electromagnetic records and electronic signatures in applications, etc. for approval of, or license for pharmaceuticals, etc. (Japanese Ministry of Health, Labour and Welfare)
- Guideline on management of computerized systems for marketing authorization holders and manufacturers of drugs and quasi-drugs (Japanese Ministry of Health, Labour and Welfare)

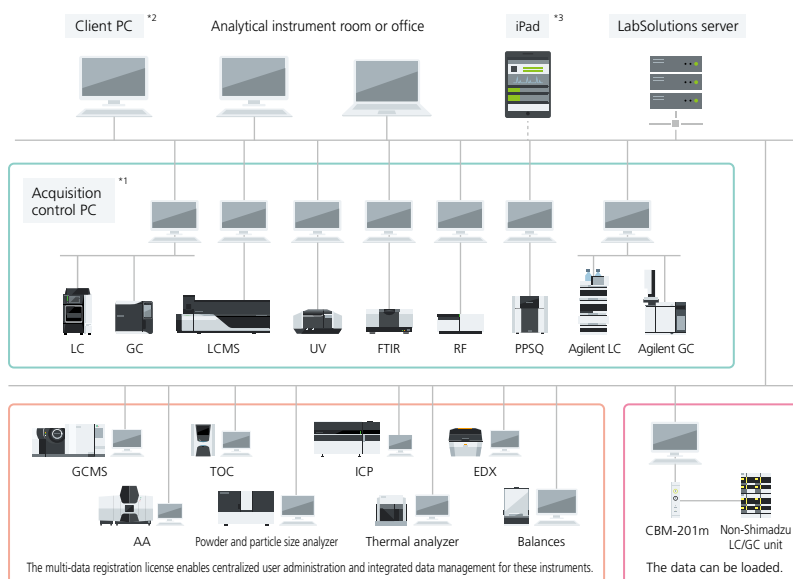

*1 The acquisition control PC controls analytical instruments.

It can also be used to send analytical instructions and perform post-run analysis, just like a client PC.

*2 If a terminal service is used, then LabSolutions software does not need to be installed on client PCs.

*3 If an iPad is used, then XenApp from Citrix must be installed. iPad is a trademark of Apple Incorporated.

LabSolutions Direct* Enables Remote Control and Monitoring

LabSolutions Direct is a new LabSolutions series remote access tool used to remotely control or monitor GC systems via a simple user interface on a commercially-available smartphone or tablet. Consequently, analyses can be performed while remotely monitoring the status of instruments from locations away from the laboratory.

* Optional

Main settings performable via a smart device:

- Starting and stopping analysis
- Monitoring chromatograms
- Checking instrument status



Directly access a GC unit in the laboratory from a smartphone or tablet computer

Application Systems Tailored to Your Analytical Requirements

Headspace Analysis System

The headspace sampler maintains the sample at a constant temperature and then injects a fixed quantity of the gas phase generated into a GC unit.

It is used for qualitative and quantitative analysis of volatile components in solid or liquid samples.

System Configuration (for GC system with headspace sampler)

Nexis GC-2030 + HS-20 Headspace Sampler + LabSolutions GC
(HS-20: Sample loop model. A model with a trap is also available.)

Nexis GC-2030 + HS-10 Headspace Sampler + LabSolutions GC
(HS-10: Cost-effective headspace sampler model with a sample loop)



Nexis GC-2030 + HS-20

Analytical Applications

Analysis of residual solvents in pharmaceuticals

Analysis of odor components in foods



Nexis GC-2030 + HS-10

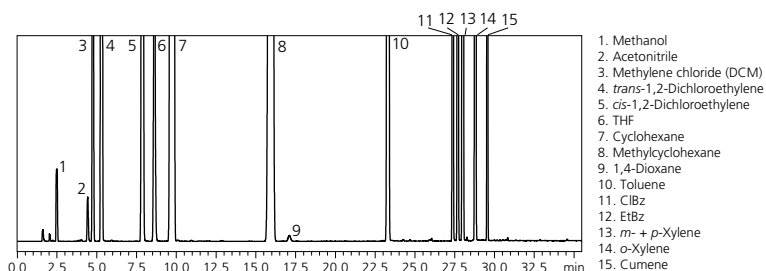

Analysis of Trace Residual Solvents in Pharmaceuticals
Using Headspace GC, Class 2 Standard Solution

Pyrolysis System

This system introduces polymer samples into a high-temperature pyrolysis furnace and then analyzes the gases and decomposition products generated from the sample.

System Configuration (GC system with pyrolyzer)

Nexis GC-2030 + Frontier Laboratories PY-3030D

(with various options available, such as auto-shot sampler and cryotrap)



Analytical Applications

Characterization of various polymer materials

Analysis of gases generated from ceramics or other inorganic materials

- | | | |
|------------------------|------------------------|---------------------------|
| 1. Tetra-BDE (BDE-47) | 4. Hexa-BDE (BDE-154) | 7. Octa-BDE (BDE-197+204) |
| 2. Penta-DBE (BDE-100) | 5. Hexa-BDE (BDE-153) | 8. Deca-BB (BB-209) |
| 3. Penta-BDE (BDE-99) | 6. Hepta-BDE (BDE-183) | 9. Deca-BDE (BDE-209) |

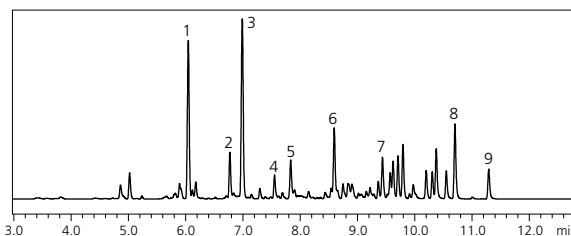

Analysis of Brominated Flame Retardants in a Plastic Product

Refinery Gas Analysis System

Specialized systems can be configured by installing multiple valves and columns in the standard Nexis GC-2030 installation space. Inorganic gases, hydrocarbons, hydrogen sulfides, and other components can be analyzed within five and a half minutes. Method development is not required because systems are assembled and tested in advance at the factory, prior to arriving at your lab.

System Configuration (refinery gas analysis system)

Nexis GC-2030 + Optional valve box + LabSolutions GC

Analytical Applications

Analysis of refinery gases emitted during petroleum refining processes

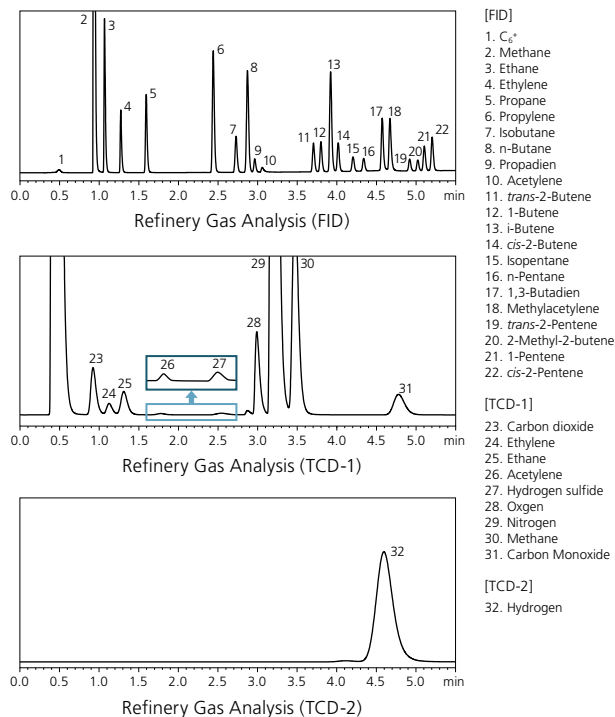

Simulated Distillation GC System

This system converts the elution times for straight-chain hydrocarbons into their corresponding boiling points, and calculates the distribution of boiling points from the elution time of respective components. It is compliant with ASTM, JIS, and various other standards that specifies distillation GC.

System Configuration (simulated distillation GC)

LabSolutions GC + simulated distillation GC software

(Injection units and columns are selected based on the intended samples and objectives.)

Analytical Applications

Calculation of distillation characteristics of various petroleum distillates

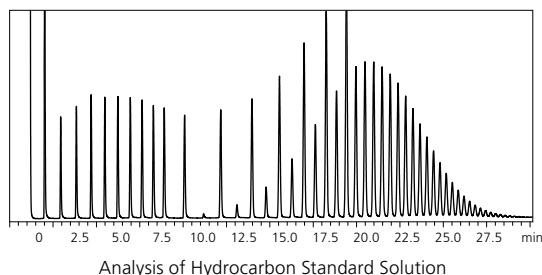
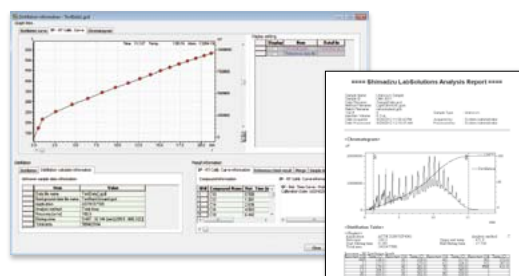

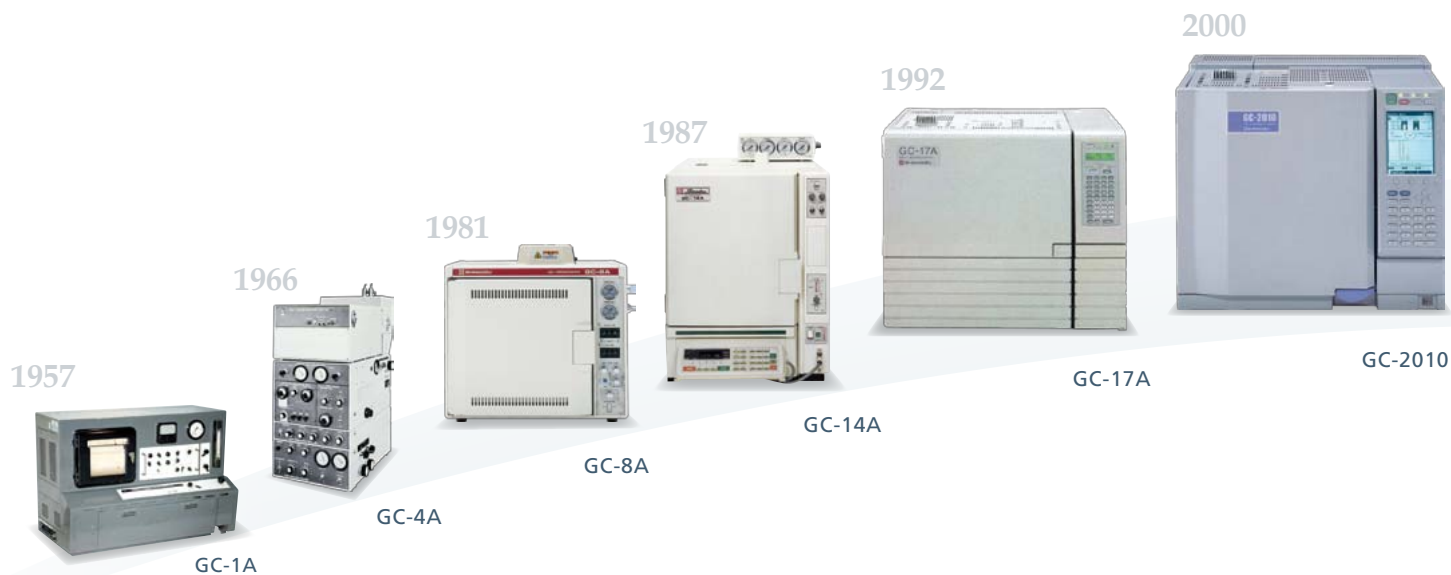

60th GC ANNIVERSARY

60 years of making chromatographs, technical expertise represented by Shimadzu Corporation manufacturing the first gas chromatograph released in Japan.

Since then, Shimadzu has continued to develop gas chromatographs, representing the first half-century of Shimadzu's 140-year history.

This tradition of excellence and quality continues until today, available and tailored to meet most customer's needs.

It represents a combination of the manufacturing spirit and Shimadzu and Japan, backed by the reliability for which "Made in Japan" is known.

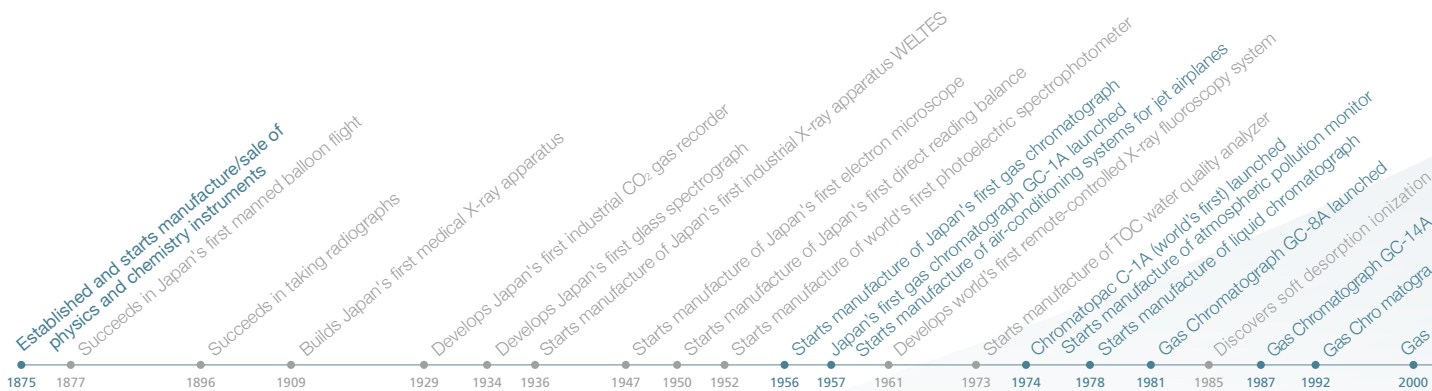



2004

GC-2014



2009

GC-2010 Plus



2010

GC-2025



2013

Tracera



2017

Nexis GC-2030

graphs based on
"Made in Japan"
ed the first gas

tograph products for over a

with various GC systems

solid technical capabilities of
in Japan" has become known.

methods
 launched
 ph GC-17A launched
 Chromatograph GC-2010 launched
 Focus starts on life sciences, semiconductors/FPD, and environmental solution businesses
 MALDI mass spectrometer AXIMA Series launched
 Koichi Tanaka awarded Nobel Prize for Chemistry
 Gas Chromatograph GC-2014 launched
 Starts manufacture of world's first X-ray
 diagnostic system equipped with direct conversion
 flat panel detector (FPD)
 Shimadzu Gas Chromatograph 50th anniversary
 Gas Chromatograph GC-2010 Plus launched
 Gas Chromatograph GC-2025 launched
 Gas Chromatograph Tracera launched
 Shimadzu Gas Chromatograph 60th anniversary
 Gas Chromatograph Nexis GC-2030 launched

2001 2002 2004 2006 2009 2010 2013 2016 2017



Shimadzu Corporation
www.shimadzu.com/an/

For Research Use Only. Not for use in diagnostic procedures.

This publication may contain references to products that are not available in your country. Please contact us to check the availability of these products in your country.

Company names, products/service names and logos used in this publication are trademarks and trade names of Shimadzu Corporation, its subsidiaries or its affiliates, whether or not they are used with trademark symbol "TM" or "®".

Third-party trademarks and trade names may be used in this publication to refer to either the entities or their products/services, whether or not they are used with trademark symbol "TM" or "®".

Shimadzu disclaims any proprietary interest in trademarks and trade names other than its own.

The contents of this publication are provided to you "as is" without warranty of any kind, and are subject to change without notice. Shimadzu does not assume any responsibility or liability for any damage, whether direct or indirect, relating to the use of this publication.